

QUALED | LED AR70 B15 7.5W 2700K 25D 540lm

- B15D Socket
- 12V
- 30.000 hours Lifetime
- Dimmable
- 87% Energy Saving
- Luminous Flux 90° Cone: 520 lm
- Equivalent to 56W incandescent bulb
- 5 Years Warranty

Product Number	52359
General Data	
Lamp Socket	B15D
Design	AR70
Electric Data	
Wattage (W)	7,5
Wattage Equivalent (W)	56
Voltage (V)	12
Dimmable	yes
Power Factor	0.90
Operating Frequency (Hz)	50/60
Geometric Data	
Length (mm)	51
Diameter (mm)	70
Weight (g)	36
Photometric Data	
Luminous Flux (lm)	540
Luminous Flux 90° Cone (lm)	520
CRI	80
CCT (K)	2700
Luminous Intensity (cd)	1650
Beam Angle (°)	25
Luminous Efficacy (lm/W)	72
Lifetime (hrs)	30.000
Switching Cycle	100.000



Product image



Technical drawing

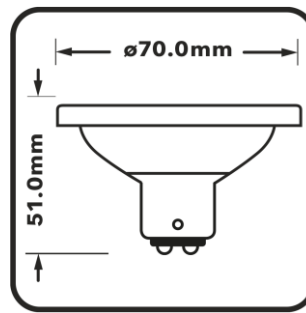

Energy Rating

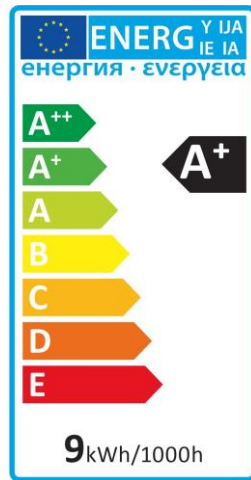
Technical Packaging
Details

Package: single

Package: 36

Pack Dimensions(HxWxL)
72*72*60 (mm)

MOQ
36

Carton Dimensions (HxWxL)
236*231*229 (mm)

Cartons/Pallet
48

Layers/Pallet
12

Units/Pallet
1728

